

electriciQ

USER MANUAL



DESIGNER PANEL HEATER

DPHW1500W

Thank you for choosing electriciQ
Please read the manual before using this heater
and keep it safe for future reference.

Visit our page www.electriQ.co.uk for our entire product range

CONTENTS

SAFETY INSTRUCTIONS	3
PRODUCT OVERVIEW	6
INSTALLATION	5
OPERATION	7
SETTING UP THE APP	8
USING THE APP	13
CLEANING AND MAINTENANCE	18
TROUBLESHOOTING	18
TECHNICAL SPECIFICATIONS	19
SUPPORT	19
PRODUCT FICHE	20

SAFETY INSTRUCTIONS

IMPORTANT

- Carefully read the instructions before operating the unit
- This appliance is for indoor use only.
- Rating: This unit must be only connected to a 220-240 V / 50 Hz earthed outlet.
- Installation must be in accordance with the regulations of the country where the unit is used.
- If you are in any doubt about the suitability of your electrical supply have it checked and, if necessary, modified by a qualified electrician.
- This heater has been tested and is safe to use. However, as with any electrical appliance - use it with care.
- Disconnect the power from the unit before dismantling, assembling or cleaning.
- Avoid touching any moving parts within the appliance.
- Never insert fingers, pencils or any other objects through the guard.
- This appliance can be used by Children aged from 8 years and above and persons with reduced physical, sensory or mental capabilities or lack of experience and knowledge if they have been given supervision or instruction concerning use of the appliance in a safe way and understand the hazards involved. Children shall not play with the appliance. Cleaning and user maintenance shall not be carried out by children.
- Children aged from 3 years and less than 8 years shall only switch on/off the appliance provided that it has been placed or installed in its intended normal operating position and they have been given supervision or instruction concerning use of the appliance in a safe way and understand the hazards involved. Children aged from 3 years and less than 8 years shall not plug in, regulate, or clean the appliance or perform user maintenance.
- Children under 3 years should be kept away unless continuously supervised.
- Some parts of this product can become very hot and cause burns. Particular attention has to be given where children and vulnerable people are present.
- Do not clean the unit by spraying it or immersing it in water.
- Never connect the unit to an electrical outlet using an extension cord. If an outlet is not available, one should be installed by a qualified electrician.
- Never operate this appliance if the unit, cord or plug is damaged. Ensure the power cord is not stretched, exposed to sharp object/edges, or routed under the unit.
- Any service other than regular cleaning should be performed by an authorised service representative. Failure to comply could result in a voided warranty.
- Never use the plug as a switch to start and turn off the heater. Use the provided power switch on the rear of the unit.
- Do not use an external timer.
- Do not cover the air inlet or outlet, or place items close to the unit which may restrict airflow, as this may present a fire risk.
- The heater must not be located immediately below a socket outlet.

- Always ensure the unit is secure before operation. Do not use on unstable or uneven surfaces and if wall-mounted, it must be securely attached to a suitable wall.
- Do not move or tilt the unit.
- Avoid keeping the unit in direct sunlight for a long period of time.
- The heater is designed to be used at temperatures above -20°C. If it is exposed to temperatures below this, it must be allowed to warm above this level before operation.
- Do not attempt to repair, disassemble or modify the appliance. This unit contains no user-serviceable parts.
- Always unplug or disconnect the appliance from the mains power supply when not in use, or when moving or cleaning it. Do not pull the cord to unplug the heater.
- Keep the heater clean. Do not allow any object to enter the ventilation or exhaust opening as this may cause electric shock, fire, or damage to the heater.
- Do not use the appliance for anything other than its intended use. It is designed for domestic indoor use only.
- There may be a trace of odour during the first few minutes of initial use, or after a period of storage. This is normal and will quickly disappear.
- This appliance has hot and arcing or sparking parts inside. Do not use it in areas where gasoline, paint, or any flammable liquids are used or stored.
- Never locate this appliance where it may fall into a bathtub or otherwise become exposed to water.
- This appliance is IP24 rated, and so can be used or installed within a bathroom as long as the appliance and its cables are not within Zones 0-2.
- If used within a bathroom, the circuit must be protected by a suitable RCD to prevent electric shock.
- Do not allow the appliance to be submerged or sprayed with water.
- If the unit is wall-mounted, it must be installed in accordance with current regulations for the area of installation. If unsure, professional advice should be sought.
- **WARNING:** To reduce the risk of fire or electrical shock, DO NOT use this appliance with any solid-state Speed Control Device or any variable speed controllers.

ENERGY SAVING AND UNIT SAFETY PROTECTION TIP

- Do not cover or restrict the airflow. Do not use in a dusty environment.
- For safety and maximum performance, when used as a portable unit the minimum distance from a wall or objects should be 50cm.

INSTALLATION

WALL MOUNTING

Ensure that there are no internal pipes or wiring where drilling will be taking place.

Mark the 4 mounting holes with a width and height of 280mm and 158mm apart as shown in the diagram. Check that the holes you have marked align with the mounting bracket and use a spirit level to ensure that the holes are level.

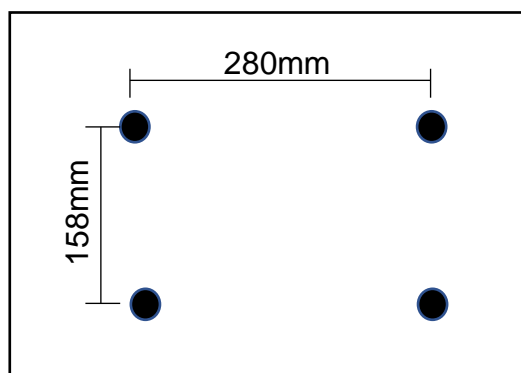

Drill the holes in the wall with an 8mm drill bit. Insert the wall plugs before fixing the mounting bracket with the 4 screws provided.

Rest the heater on the mounting bracket and tilt the bottom of the heater to about 45° so that the bottom slots fit over the bottom pegs of the mounting bracket.

Lift the heater slightly so that the bottom pegs lock, then push it in so that its top slots fit onto the top pegs of the mounting bracket.

Press the appliance in with moderate pressure until it clicks into place, then secure by tightening the screws.

FREESTANDING

Assemble the stand and fix together using the four screws provided (3x6mm).

Fit the stand to the bottom of the heater, and fix it in place using four screws on each side (4x12mm). Ensure that the stand is stable.

Ensure that everything is securely fastened in place before use.

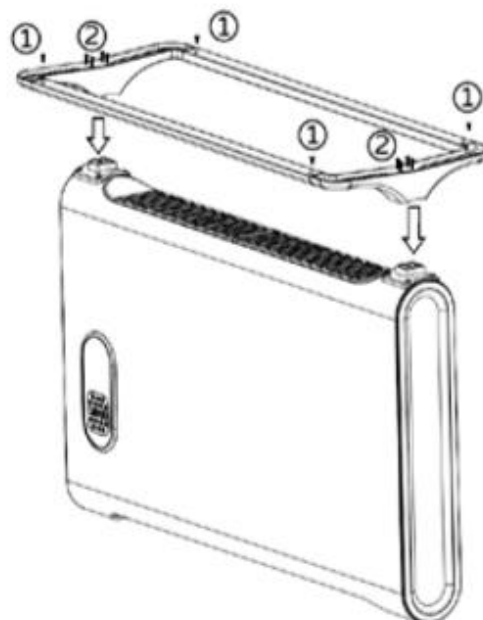





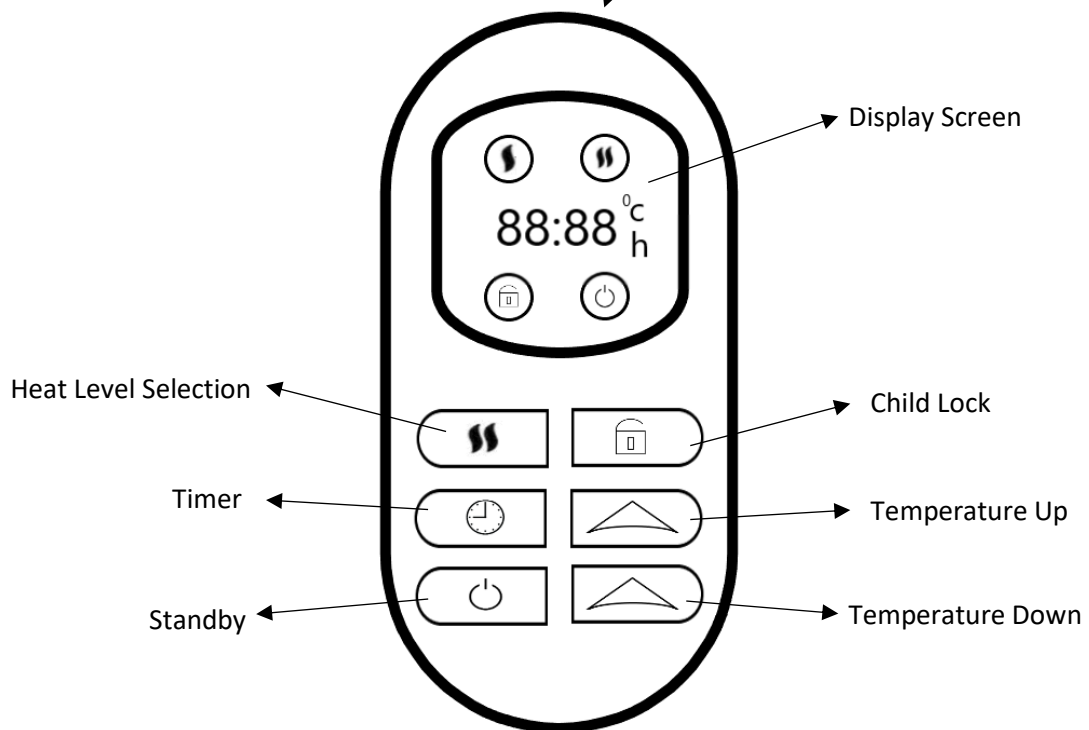

PRODUCT OVERVIEW



CONTROL PANEL



OPERATION

<p>Standby</p> 	<p>The Standby button is used to turn the unit on and off. When turned on the LCD will be illuminated and the room temperature displayed.</p>
<p>Heat Level</p> 	<p>The Heat Level button changes between Eco Mode (750W), and Rapid Heat (1500W). The display will indicate the currently selected level.</p>
<p>Child Lock</p> 	<p>Hold the Child Lock button for 5 seconds to lock the control panel, when the unit is in child lock mode, all other buttons are deactivated. A lock symbol will appear on the screen. To exit child lock, press and hold the button again for 5 seconds.</p>
<p>Temperature Up</p> 	<p>The Temperature Up button increases the desired room temperature (Range:5-40°C). When the room temperature is above the level set, heating will be turned off. After pressing this button the display will show the desired temperature, and will revert to showing the room temperature after a few seconds of inactivity.</p>
<p>Temperature Down</p> 	<p>The Temperature Down button decreases the temperature (Range:5-40°C). When the room temperature is above the level set, heating will be turned off. After pressing this button the display will show the desired temperature, and will revert to showing the room temperature after a few seconds of inactivity.</p>
<p>Timer</p> 	<p>The inbuilt timer will allow you to set the unit to turn off after a set period of time. Please note this timer is a one use timer, and starts operation when programmed.</p> <ol style="list-style-type: none"> 1. While the unit is operating, repeatedly press the timer button to set the duration 2. Once the set time has elapsed, the unit will turn off automatically. <p>Press the POWER button before the time has elapsed, the timer will be cancelled and the unit will turn off.</p>

CONNECTING THE APPLIANCE TO WIFI

DOWNLOAD THE APP TO YOUR PHONE

Download the "TUYA SMART" app, from your chosen app store, using the QR codes below, or by searching for the app in your chosen store.



Android



IOS

MODES AVAILABLE FOR SETUP

The heater has two different setup modes, Quick Connection and AP (Access Point). The quick connection is a quick and simple way to set the unit up. The AP connection uses a direct local WiFi connection between your phone and the heater to upload the network details.

To turn the WiFi on, press and hold the HEAT LEVEL button for 5 seconds until the heater bleeps. The WiFi symbol will flash quickly to indicate the unit is in quick connection mode

Please ensure your device is in the correct WiFi connection mode for the connection type you are attempting, the flashing WiFi indicator on your heater will indicate this.

Connection Type	Frequency of Flashes
Quick Connection	Flashes twice per second
AP (Access Point)	Flashes once per five seconds

CHANGING BETWEEN CONNECTION TYPES

To change the unit between connection modes press and hold the HEAT LEVEL button for 3 seconds.

REGISTER THE APP

1. Press on the register button at the bottom of the screen.

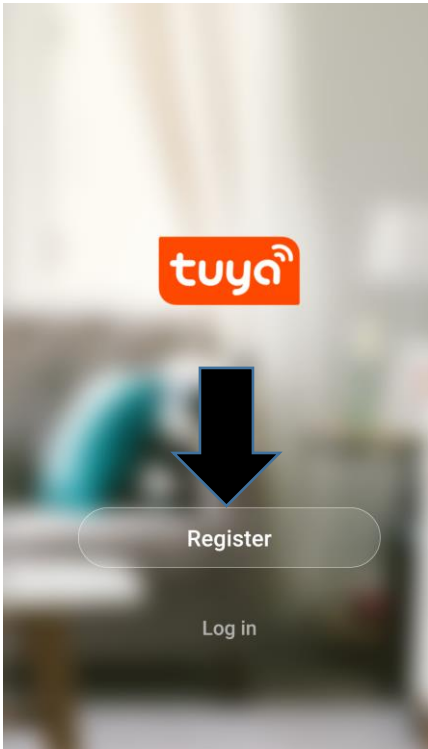

2. Read the Privacy policy and press the Agree Button.

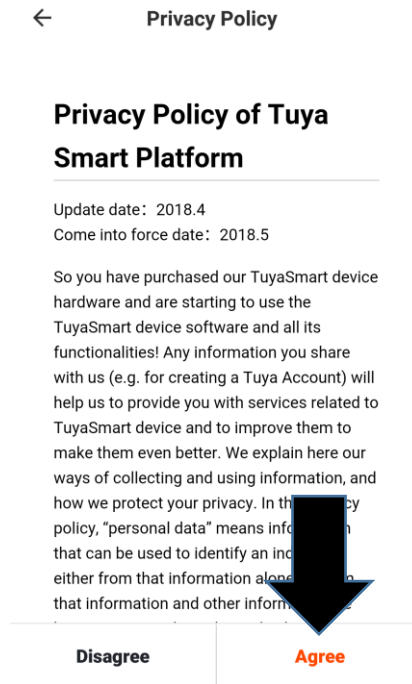

3. Enter your email address or phone number and press continue to register.

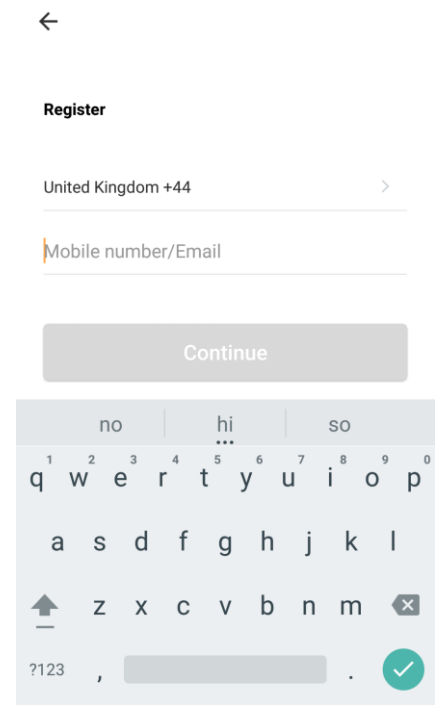

4. A verification code will be sent by the method selected in step 3. Enter the code into the app.

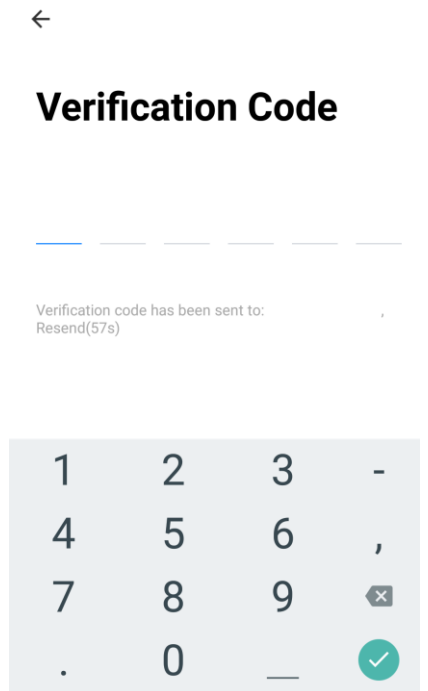

5. Type in the password you would like to create. This needs to be 6-20 characters, with letters and numbers.

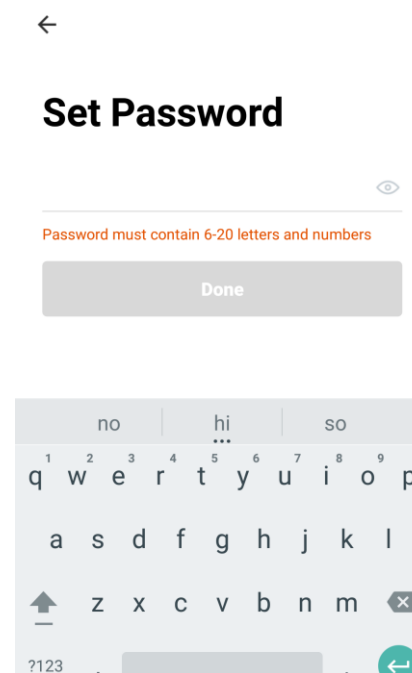

2. The app is now registered. It will automatically log you in.

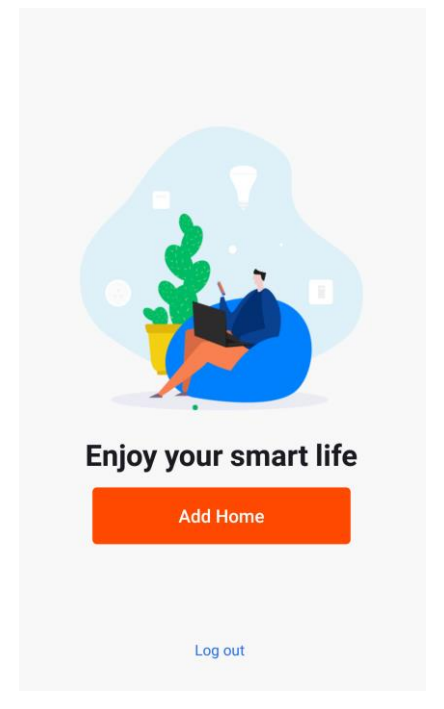

SETTING UP YOUR HOME WITHIN THE APP

TUYA is designed so it can work with a large number of compatible smart devices within your home. It can also be set up to work with multiple devices within different houses as such during the setup process, the app requires that different areas are created and named to allow easy management of all your devices. When new devices are added, they are assigned to one of the rooms you have created.

CREATING ROOMS

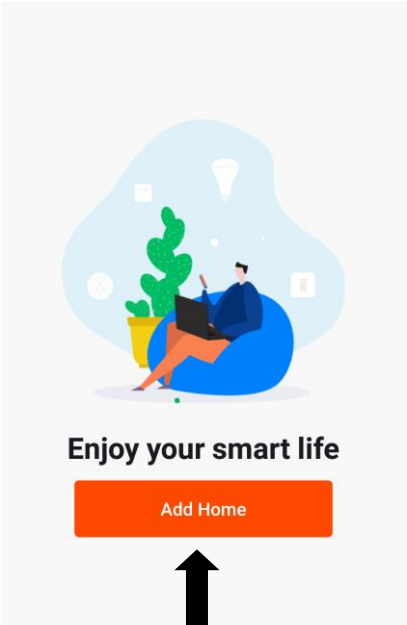
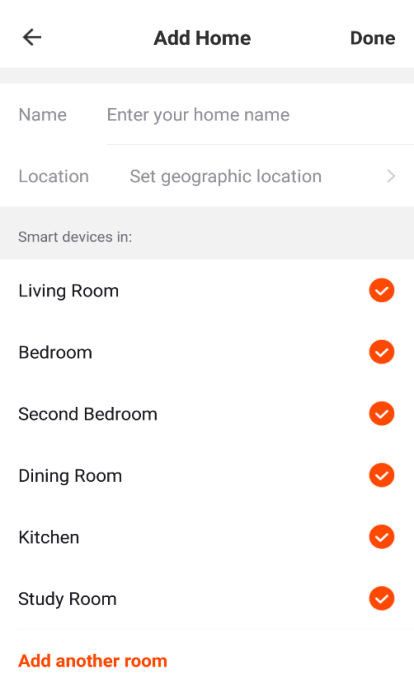
<p>1. Press on the ADD HOME button.</p> 	<p>3. Type in a name for your home, 4. Press on the location button to select the location of your home. (See SETTING YOUR LOCATION below) 5. New rooms can be added by pressing the ADD ANOTHER ROOM option at the bottom. (See ADD ANOTHER ROOM below) 6. Untick any rooms that are not required on the app. 7. Press DONE in the top right corner.</p>	
--	---	--

SETTING YOUR LOCATION

Use your finger to move the orange HOME symbol.

When the symbol is in the approximate location of your home, press the confirm button in the top right corner.

Location details allows the app to be set up later to respond to weather conditions in your area.

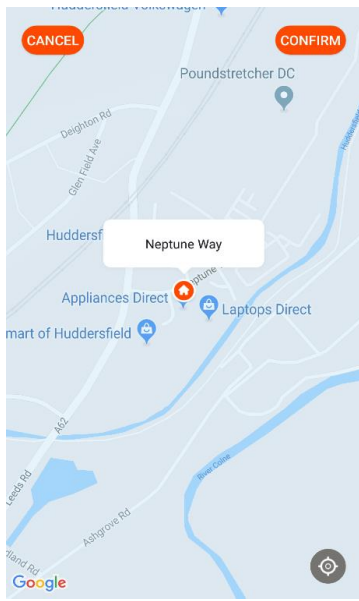

ADD ANOTHER ROOM

Type in the name of the room, and press Done in the top right corner

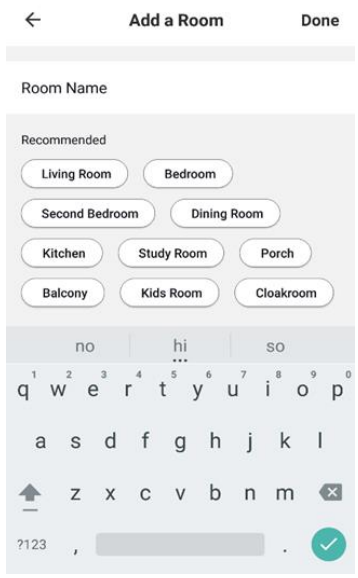

CONNECTING USING THE QUICK CONNECTION METHOD

Before initiating the connection, make sure the WiFi indicator is flashing twice per second. If not follow the instructions for changing the connection mode. Also ensure your phone is connected to the WiFi network. (We advise turning mobile data off during setup)

1. Open app and press “+” to add device, or use the add device button

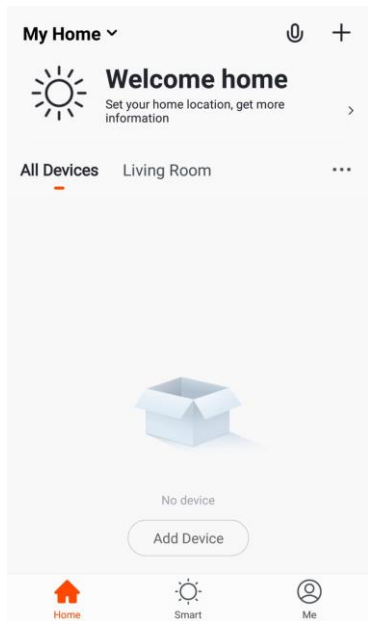

2. Select the type of device as “Heater” within the Home Appliance tab.

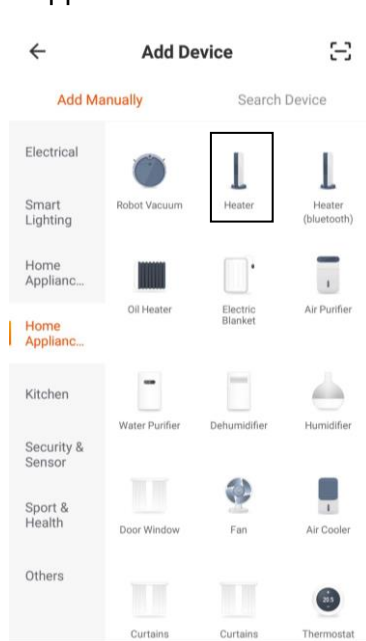

3. Press on the orange button at the bottom of the screen.

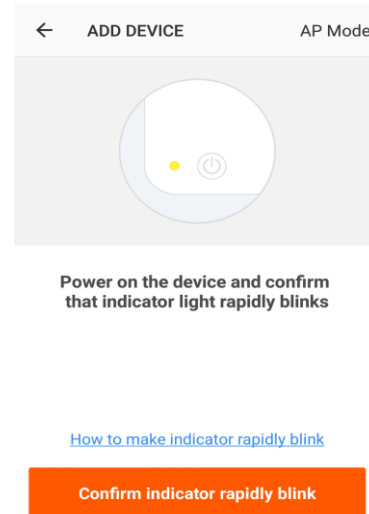

4. Enter your Wi-Fi password and press confirm.

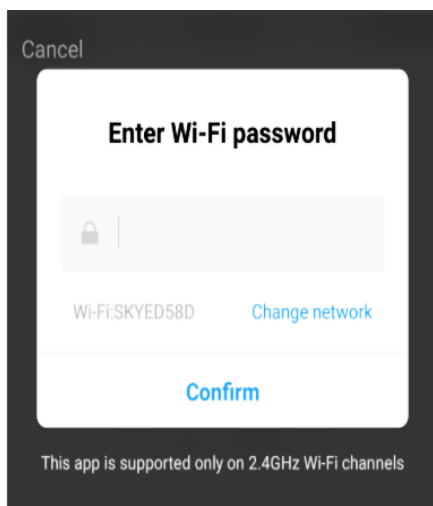

5. This will then transfer the settings to the heater. Wait for this to complete. If this fails, retry.

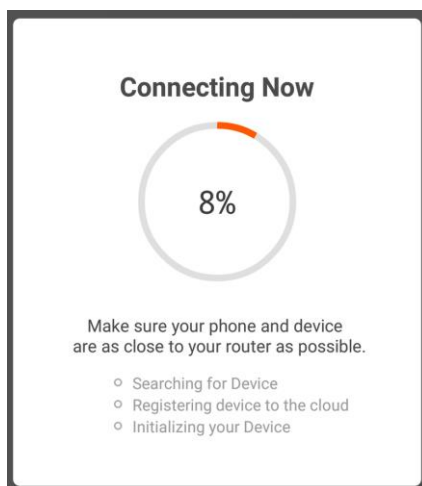

CONNECTING USING AP MODE (ALTERNATIVE METHOD)

Before initiating the connection, make sure the unit is in standby mode, with the WiFi Indicator flashing once per second. If not follow the instructions for changing the WiFi connection mode. Also ensure your phone is connected to the WiFi network. (We advise turning mobile data off during setup)

1. Open app and press “+” to add device, or use the add device button

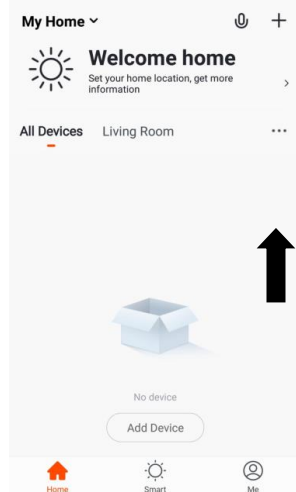

2. Select the type of device as “Heater” within the Home Appliance tab.

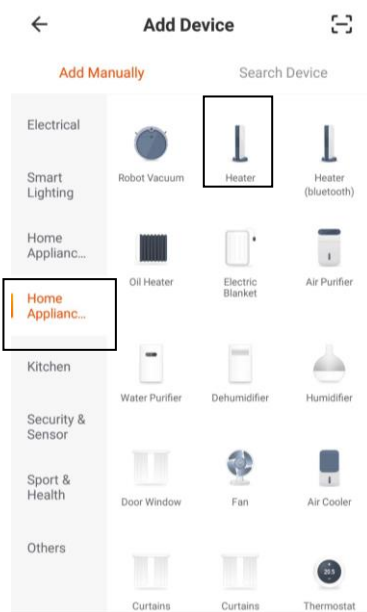

3. Press on the AP mode button in the top right of the screen.

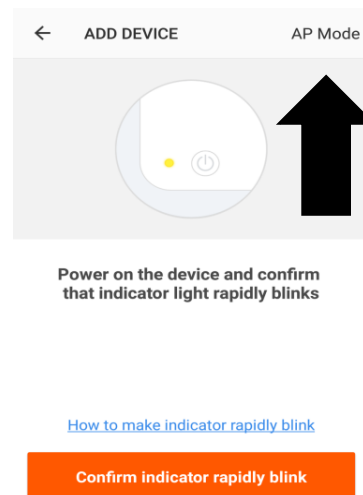

4. Ensure the WiFi indicator on the heater is slowly flashing (once per second), then press on the orange button at the bottom of the screen to confirm

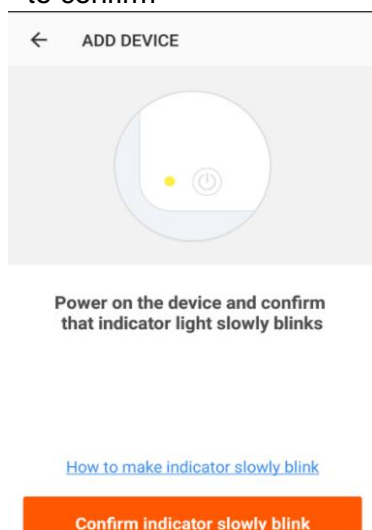

5. Enter your WiFi password and press confirm.

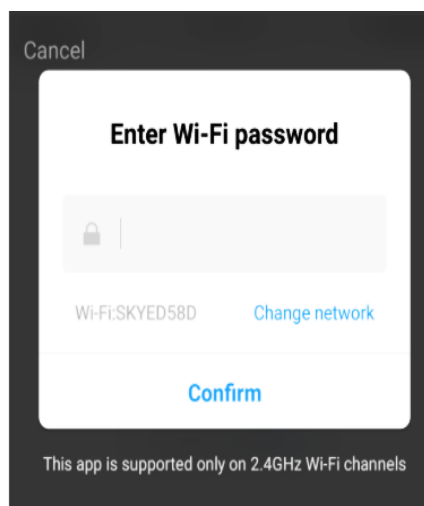

6. Go to network settings in your phone and connect to the “SmartLife xxx” connection. There is no password to enter. Then return back to the app to complete setup.

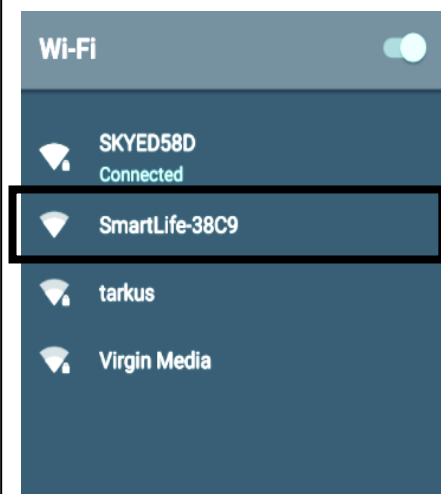

This will then transfer the settings to the heater.

Once the connection process has completed, go back to the network settings on your phone to ensure your phone has reconnected to your WiFi router.

CONTROLLING YOUR APPLIANCE THROUGH THE APP

THE HOME SCREEN

Each device has its own entry on the home screen to allow the user to either quickly turn the unit on or off, or to enter the device screen to make other changes.

Voice Control: Press to give verbal instructions for operation.

Add Device: Add a device to the app, and go through the setup process.

Name of Heater: Press to enter the Device Screen

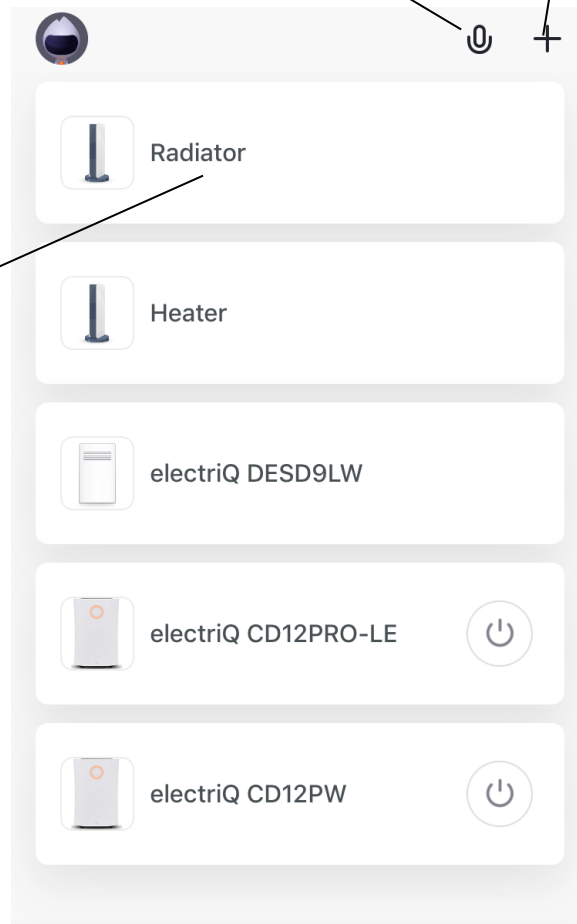

Home: Return to home screen from the Smart Scene and Profile screens

Smart Scene: Allows you to program intelligent behaviour based on the internal and external environment

Profile: Provides the option for changing settings,

DEVICE SCREEN

The device screen is the main control screen for the heater, providing access to the controls to amend the functions and settings.

Back: Returns to the Home Screen

Device Name: Panel heater-vdevo

Edit Name: Use to change the name of the heater

Desired Temperature: Displays what has been set as the target room temperature.

Current Temperature: Displays what the current temperature is.

Increase Desired Temperature
Temperature range 5-40C

Decrease Desired Temperature
Temperature range 5-40C

WEEKLY TIMER:
Use to program the heater to change the operation and desired temperature throughout the week.

Power: Use to turn the unit on or off.

HEAT:
Use to change between Low Heat and High Heat.

CHILD LOCK:
Use to lock the controls on the heater.

COUNTDOWN TIMER:
Use to add an off timer while the unit is running, or an on timer while the unit is turned off

The screenshot shows a red interface with a central temperature display of 35°C. Below the display are minus and plus buttons for adjusting the desired temperature. At the bottom is a navigation bar with icons for Power, Heat, Child Lock, Timer, and Weekly Timer.

NOTE: Due to continuous development of the app, the layout and available features may be subject to change.

SMART SCENES

Smart Scenes is a powerful tool providing the option to customize the operation of the air heater based both on conditions within the room and outside influences. This gives the user the option of specifying much more intelligent actions. These are split into two categories Scene and Automation.

SCENE

Scene allows for a one touch button to be added to the Home Screen. The button can be used to change a number of settings in one go, and can change all the settings within the unit. A number of scenes can easily be setup, allowing the user to easily change between a number of preset configurations.

Below is an example of how to set up a scene:

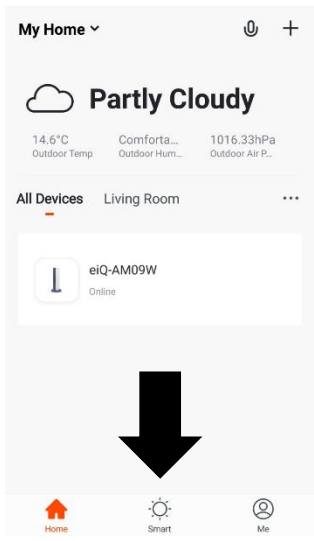
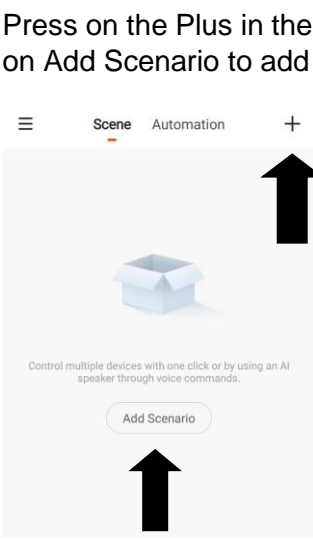
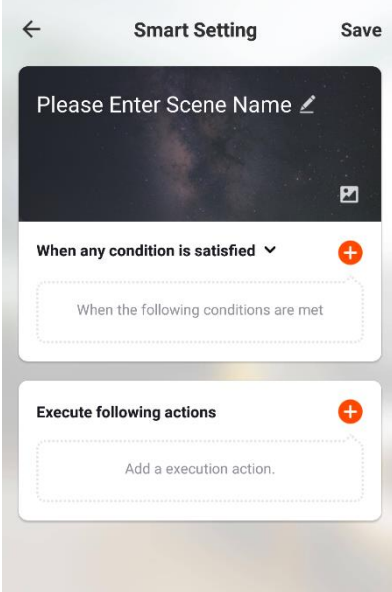
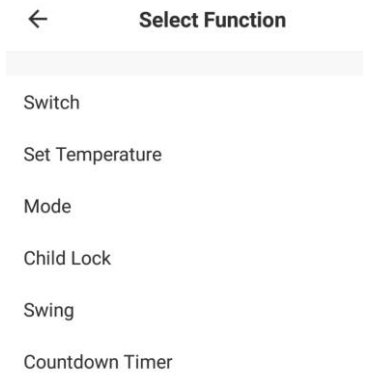
<p>1. Press on the Smart tab at the bottom of the Home screen</p> 	<p>2. Press on the Plus in the top right corner or on Add Scenario to add a smart scene.</p> 	
	<p>3. Press the Pen next to "Please Enter Scene Name" to input the name for your Scene</p> <p>Show on Dashboard: Leave this on if you require the scene to be displayed as a button on the Home Screen</p> <p>Press the Red Plus to add the action required. Then select the heater from the list of devices.</p>	<p>4. Chose the function, set the value for the function, and then press the back button in the top right corner, to return to the previous screen.</p> 
<p>6. Once all the functions required have been added, press the Save button in the top right corner to finalize and save your new Scene. It will then be saved to the home screen</p>		

AUTOMATION

Automation allows an automatic action to be set up for the device. This can be triggered by the Time, and a range of other influences, depending what other TUYA enabled devices you have on the network.

1. Press on the Scene tab at the bottom of the Home screen

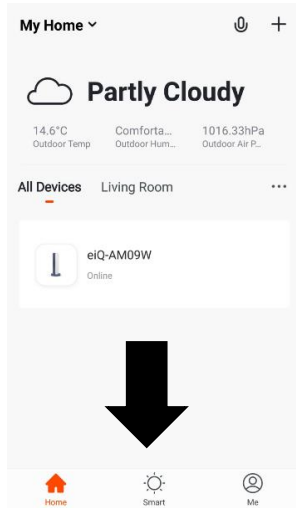

2. Press on the Automation tab at the top of the screen.

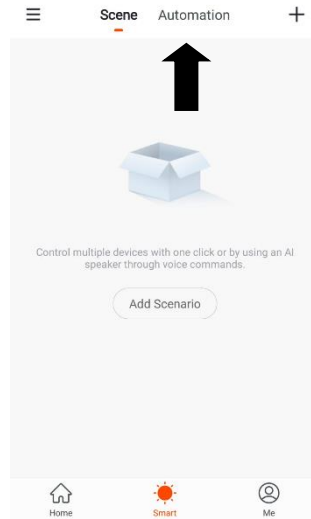

3. Press on the + at the top of the screen or press on Add Automatic Action

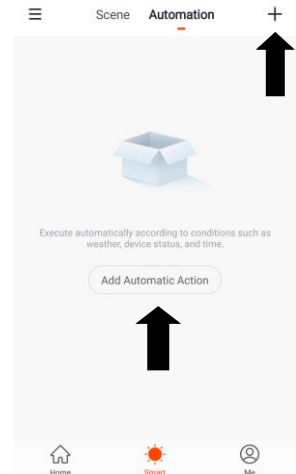

Select Function

- Switch >
- Set Temperature >
- Mode >
- Child Lock >
- Swing >

4. Setup is very similar to the scene setup on the previous page, and includes an extra section for specifying a trigger for the scene to start.

Press the Pen next to "Please Enter Scene Name" to input the name for your Scene

Press the Red Plus next to "When any condition is satisfied" to add the trigger

Press the Red Plus next to "Execute following actions" to add the action required. Then select the heater from the list of devices.

5. Select the condition when the automation should start. A number of triggers can be combined.

Select Function

- Switch >
- Set Temperature >
- Mode >
- Child Lock >
- Swing >
- Countdown Timer >

6. Chose the function, set the value for the function, and then press the back button in the top right corner, to return to the previous screen.

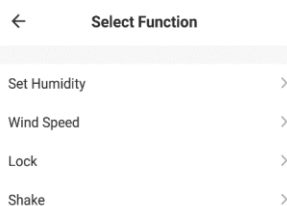

7. Once all the functions required have been added, press the Save button in the top right corner to finalize and save your new scene.

The automation is now set up, it can be turned on and off using the toggle on the home page.

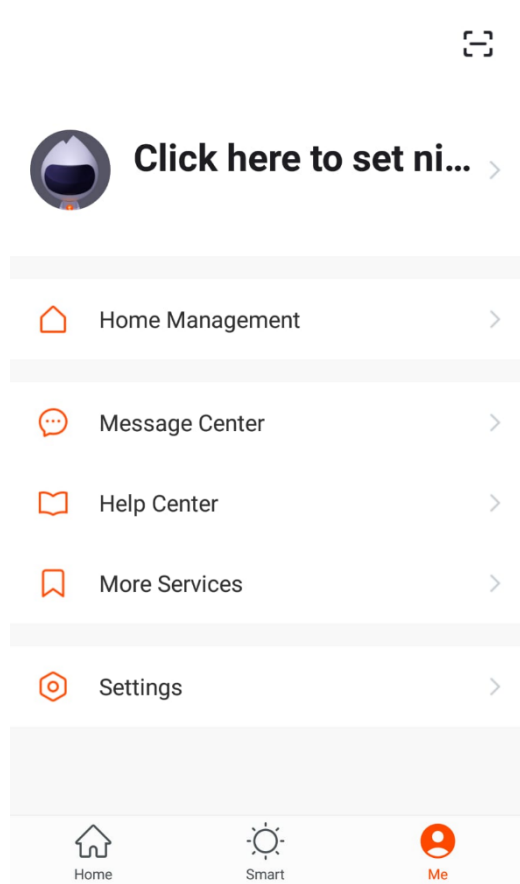

PROFILE TAB

The profile tab gives you the option to edit both your detail, and use the added features of the unit.

HOME MANAGEMENT

Home Management provides options for managing your TUYA account, giving options such as adding a home, adding and removing rooms, and sharing devices with family.

MESSAGE CENTRE

View notifications from devices, if alarms are set up (dependent on device)

HELP CENTRE

Provides assistance using the features provided within the app

MORE SERVICES

This allows the unit to be integrated with your favorite home automation hardware such as Google Home and the Amazon Echo.

CONNECTION TROUBLESHOOTING

1. Ensure the Wi-Fi password has been entered into the app correctly (Case sensitive)
2. Check that the phone is connected to the Wi-Fi you are connecting the device to.
3. Ensure the network you are connecting it to is 2.4Ghz (5Ghz Wi-Fi networks are not supported), and that there is a strong Wi-Fi signal to the item.
4. If your router is dual band, ensure that the 2.4ghz network has a different network name (SSID). Further advice on changing router settings will be available from your Internet service provider / Router manufacturer.
5. Check the settings on the router. Encryption should be WPA2-PSK and authorisation type should be set to AES

CLEANING AND MAINTENANCE

ATTENTION: Please shut off the unit and unplug from the mains before cleaning or performing any maintenance.

CLEANING THE SURFACE

- Clean the heater with a duster or a soft wet cloth.
Do not use chemical solvents (such as benzene, alcohol or gasoline) as they may cause irreversible damage. Make sure no water enters the control panel or gaps in the casing.
- Do not run the unit until completely dry.
- Place the heater in its original box or cover to protect it from dust when not in use.
- Store it in a cool dry place.

TROUBLESHOOTING

Do not repair or disassemble the unit by yourself, unauthorized repair attempts will invalidate the warranty and may cause bodily harm.

Issue	Possible Reason	Solution
No power	1. Power cord is unconnected 2. There is no power from socket 3. The power switch on the rear of the unit is turned off.	1. Connect the power cord 2. Check socket is turned on 3. Ensure the power switch on the rear of the unit is in the on position
Odour emission from unit	1. New unit. When the unit is used for the first time the fan motor may produce and odour which will dissipate within a week of use	1. No action required
Strong vibrations and noise	1. Unit is not placed on a flat surface 2. Unit may be damaged	1. Place on a flat surface. May put an anti-vibration mat underneath 2. If the heater is damaged discontinue use and contact the service centre.

If the above solutions do not resolve the problem please contact the service centre.

TECHNICAL DATA

Model no.	DPHW1500W
Voltage	220V-240V 1.5kW
Frequency	50 / 60 Hz
Max power	750W/1500W
IP Rating	IP24
Product Dimensions	710x240x470mm

electriQ UK SUPPORT

www.electriQ.co.uk/support

Please, for your own convenience, make these simple checks before calling the service line.

If the unit still fails to operate call: 0330 390 3061 or complete the online form

1. Is the unit plugged into the mains?
2. Is the fuse OK?
3. Switch the unit off and wait three minutes to see if the issue is resolved. Restart the unit.

Office hours: 9AM - 5PM Monday to Friday

www.electriQ.co.uk
Unit J6, Lowfields Business Park
Lowfields Way, Elland
West Yorkshire, HX5 9DA

DECLARATION OF CONFORMITY

Hereby, electriQ declares that this heater follows Directive 2014/53/EU. The full text of the EU declaration of conformity is available at the following internet address:

<https://www.electriQ.co.uk/content/declaration-of-conformity>

Disposal: Do not dispose this product as unsorted municipal waste. Collection of such waste must be handled separately as special treatment is necessary.



Recycling facilities are now available for all customers at which you can deposit your old electrical products. Customers will be able to take any old electrical equipment to participating civic amenity sites run by their local councils. Please remember that this equipment will be further handled during the recycling process, so please be considerate when depositing your equipment. Please contact the local council for details of your local household waste recycling centres.

Model Identifier: DPHW1500W					
Item	Symbol	Value	Unit	Item	Unit
Heat Output				Type of heat input, for electric storage local space heaters only (select one)	
Nominal heat output	P_{nom}	1.5	kW	manual heat charge control, with integrated thermostat	No
Minimal heat output	P_{min}	0.75	kW	manual heat charge control with room and/or outdoor temperature feedback	No
Maximum continuous heat output	P_{max}	1.5	kW	electronic heat charge control with room and/or outdoor temperature feedback	No
Auxiliary electricity consumption				fan assisted heat output	No
At nominal heat output	e_{lmax}	N/A	kW	Type of heat output/room temperature control (select one)	
At minimum heat output	e_{lmin}	N/A	kW	single stage heat output and no room temperature control	No
In standby mode	e_{lsb}	1	W	two or more manual stages, no room temperature control	No
				with mechanical thermostat room temperature control	No
				with electronic room temperature control	No
				with electronic room temperature control plus day timer	No
				with electronic room temperature control plus week timer	Yes
				Other control options (multiple selections possible)	
				room temperature control with presence detection	No
				room temperature control, with open window detection	No
				with distance control option	Yes
				with adaptive start control	No
				with working time limitation	No
				with black bulb sensor	No
Contact Details	electriQ, Unit J6, Lowfields Business Park, Lowfields Way, Elland, West Yorkshire, HX5 9DA				